

Before Installation

Please read these instructions carefully and keep for future reference.

The information in this document is subject to change without notice. For updates please refer to our website.

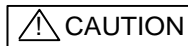

Do not use the products outside the rated power supply voltage range specified in the Specifications. It may cause a fire or damage to equipment.

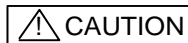

Do not disassemble, repair, or modify the products. It may cause a fire or electric shock.

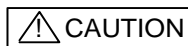

Make sure to turn the power off before commencing any wiring work. Otherwise it may cause electric shock or damage to equipment.

Note: Follow the requirements for the installation of the product in accordance with the Specifications. Otherwise it may cause malfunction.

Note: Do not install the product in any location where oil, dust, iron powder, chemicals, or hydrogen sulphide may occur or affect the product. It may cause damage to equipment.

Section 1 – INTRODUCTION

1.1 General description

The **EVA-PYH3** is an attractively-styled, low profile, analog addressable, combination photoelectric smoke/heat detector for use with the Nittan Control Panel NFU-7000 series in analog fire alarm systems.

This analog addressable combination smoke/heat detector has a specific detector address to provide exact detector locations throughout the installation. This allows for constant monitoring of the detector sensitivity and reports the detector's condition to the fire alarm control panel.

1.2 LED Indicator

LED Indicators for 360° visibility (OMNIVIEW™ 360°) of EVA-PYH3 operate as follows:

Green LED flashes in normal operation.

Red LED illuminates and Green LED flashes in an alarm condition.

1.3 EVA-PYH3 features

- * Low profile, stylish appearance
- * Soft addressing
- * Low monitoring current
- * Supplied with protective dust cover
- * OMNIVIEW™ 360° LED Indicator for polling and fire alarm indication
- * Photoelectric detector, detecting visible particles of combustion
- * Heat detector, 8.3 °C (15 °F) rate-of-rise temperature heat detector with 57 °C (135 °F) fixed temperature alarm.
- * Automatic compensation for smoke detector contamination

Section 2 – GENERAL OPERATION

The **EVA-PYH3** chamber consists of a light emitting diode (LED) and photodiode arrangement. The chamber contains a unique design which allows smoke to enter the chamber while preventing external light from affecting the photodiode. The **EVA-PYH3** has chemically etched, stainless steel insect screen therefore reducing the ingress of insects and airborne contaminants. The chamber is designed so that the light emitted by the LED is not directed to the photodiode. In the event of fire, particles of smoke enter the chamber and scatter the light in the active area of the chamber. The scattering effect increases the light in the chamber, causing more light to be detected by the photodiode. The photodiode input level is sampled to sense smoke density and transmitted as a digitally encoded value to the control panel. When the smoke density exceeds a preset threshold in the control panel, the control panel indicates a fire alarm condition.

The control panel can adjust the detector alarm threshold to compensate for contamination that might accumulate in the chamber within the smoke detector limits.

The **EVA-PYH3** heat detector portion initiates an alarm in response to both 8.3 °C (15 °F) rate-of-rise temperature or a 57 °C (135 °F) fixed temperature alarm point. Heat detector portion incorporates a highly linear thermistor circuit, with the thermistor mounted externally. The specially designed cover protects the thermistor while allowing maximum air flow. The thermistor circuit produces a voltage proportional to temperature which is scaled, and transmitted as a digitally encoded value to the control panel.

Section 3 – DIMENSIONS

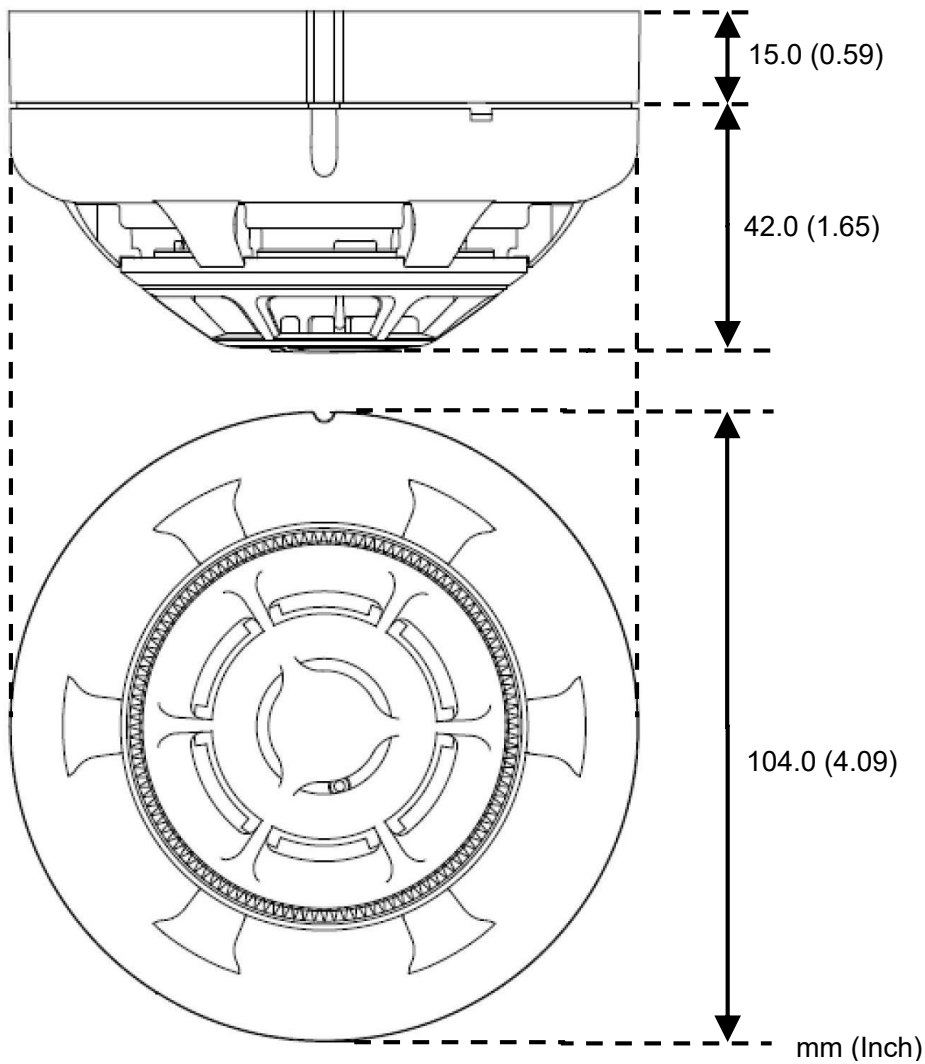

Figure 1: Dimension of EVA-PYH3

Section 4 – TERMINALS

The **EVA-PYH3** combination smoke/heat detectors have three terminal connections and the terminals are configured as follows:

Table 1: Terminal function

Terminal	Description
1	SLC Positive
6	SLC Negative
3	To activate EVA-STB-RL Relay Base

Note: Terminal 3 is used for the Relay Base EVA-STB-RL.

Section 5 – BASE MODELS

There are 5 mounting bases that are available for use with the **EVA-PYH3**. In order to operate correctly, it is important to use the appropriate mounting base as indicated in the table below. Refer to the specific mounting base instruction manuals for details.

Table 2: Mounting bases and adapter

Model	Description	Diameter	Number of Terminals
EVA-UB4	Standard mounting base	4 inch	4
EVA-UB4-6*	Larger mounting base	6 inch	4
EVA-S6 Base	Sounder base	6 inch	5
EVA-STB-RL	Relay base	4 inch	6
EVA-STB-SCI	Short circuit isolator base	4 inch	4
STBA-ADP**	Adapter mounting plate	6 inch	-

* The Model EVA-UB4-6 mounting base is intended for applications where a 4 inch square or octagonal electrical junction box is required.

** The STBA-ADP Adapter Mounting Plate is intended for the EVA-STB-RL Relay Base and EVA-STB-SCI Short Circuit Isolator Base for applications where a 4 inch square or octagonal electrical junction box is required.

Section 6 – ADDRESS SETTING

The **EVA-PYH3** requires compatible addressable communications to the control panel in order to function properly. All detectors have random addresses from the factory before installation. The EVA-AD2 Address Programmer is used for setting the address between 1 and 254 decimal of all devices prior to installation. See Annex A for the handling. Once addressed, connect and configure these detectors to UL listed Control Panel NFU-7000 series.

Section 7 – INSTALLATION

7.1 Before installing

These combination smoke/heat detectors must be installed in compliance with the manuals of the Control Panel NFU-7000 series.

The installation must meet the requirements of the Authority Having Jurisdiction (AHJ).

The combination detectors offer maximum performance when installed in compliance with the National Fire Protection Association (NFPA); see NFPA 72.

Note: NITTAN COMPANY, LIMITED is not responsible for the product which is improperly installed, maintained and tested.

7.1.1 Location requirement

When installing the detector please consider the following items. Otherwise the detector might not provide optimum performance.

- Indoor use only.
- Place the detector away from a ventilation fan or the air outlet of air conditioner, at least 1.5 m (5 ft.).
- On the ceiling, place the detector at least 10 cm (4 in.) from the wall.
- On the wall, place the detector between 10 to 30 cm (4 to 12 in.) below the ceiling.

The detector should not be installed in places such as:

- Place with plenty of air flow (close to a ventilation fan, air conditioner, or place with drafts)
- Place close to heating appliance
- Place with a constantly high temperature or humidity
- Place with lots of dust or insects
- Place where vapor can directly come in
- Place with exhaust gas such as garage

7.2 Heat detector applications

Heat detectors sense change in air temperature and initiate an alarm condition based on a fixed-temperature point, rate of temperature rise, or amount of temperature rise above ambient condition. Spot type heat detectors should be selected so that the rating is at least 11 °C (20 °F) above maximum expected ceiling temperature. Ceiling height, construction, and ventilation play significant roles in detector performance and must be considered when determining detector placement. The operating temperature range is 0 °C to 38 °C (32 °F to 100 °F).

7.2.1 Spacing of heat detectors

Spot type heat detector spacing is based on detector installation on a flat smooth ceiling at 3 m (10 ft.) high. Spacing of spot type detector is shown in Figure 2. The coverage area of a detector is represented as a square. Actual detector coverage covers a circle whose radius is 0.7 times the listed spacing. Since all of the area within the detector's circle of coverage is suitable for detecting a fire, the shape and dimensions of the detector coverage "square" in Figure 3 may be modified. Coverage area should remain within the overall detector circle of coverage as shown in Figure 4.

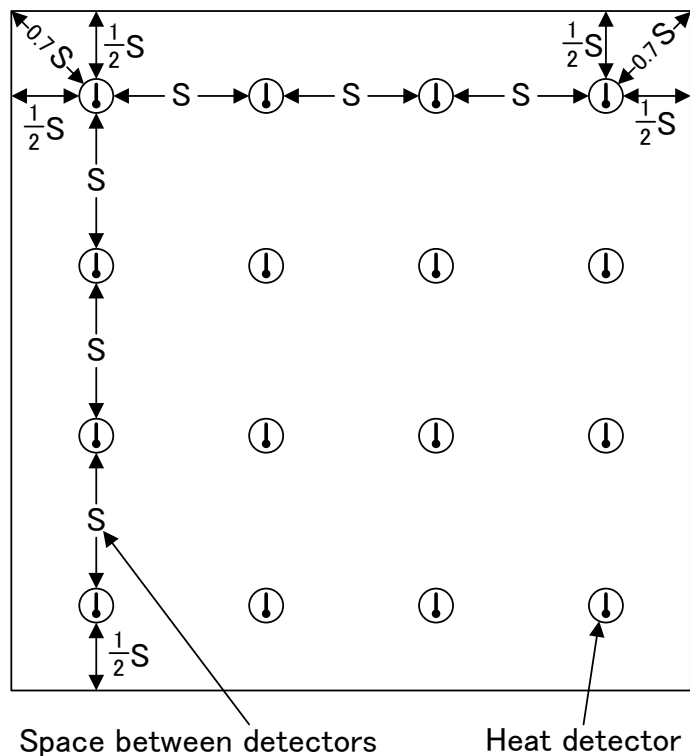

(1) Heat detector; S = Listed spacing between detectors

Figure 2: Listed heat detector spacing

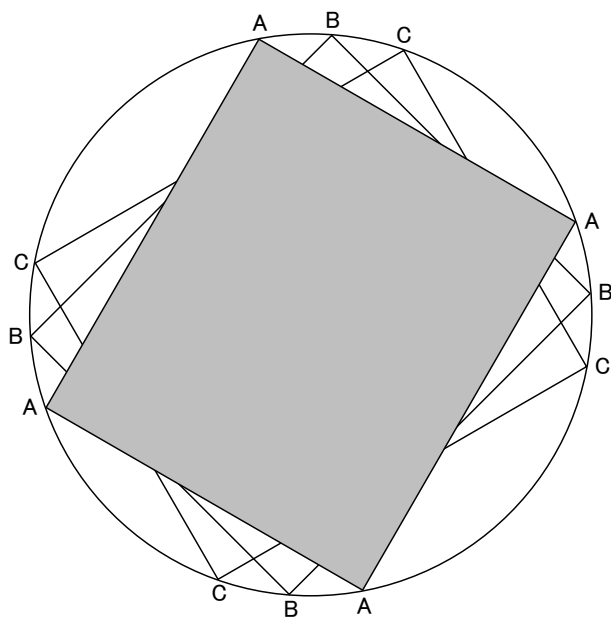

Figure 3: Detector circle of coverage

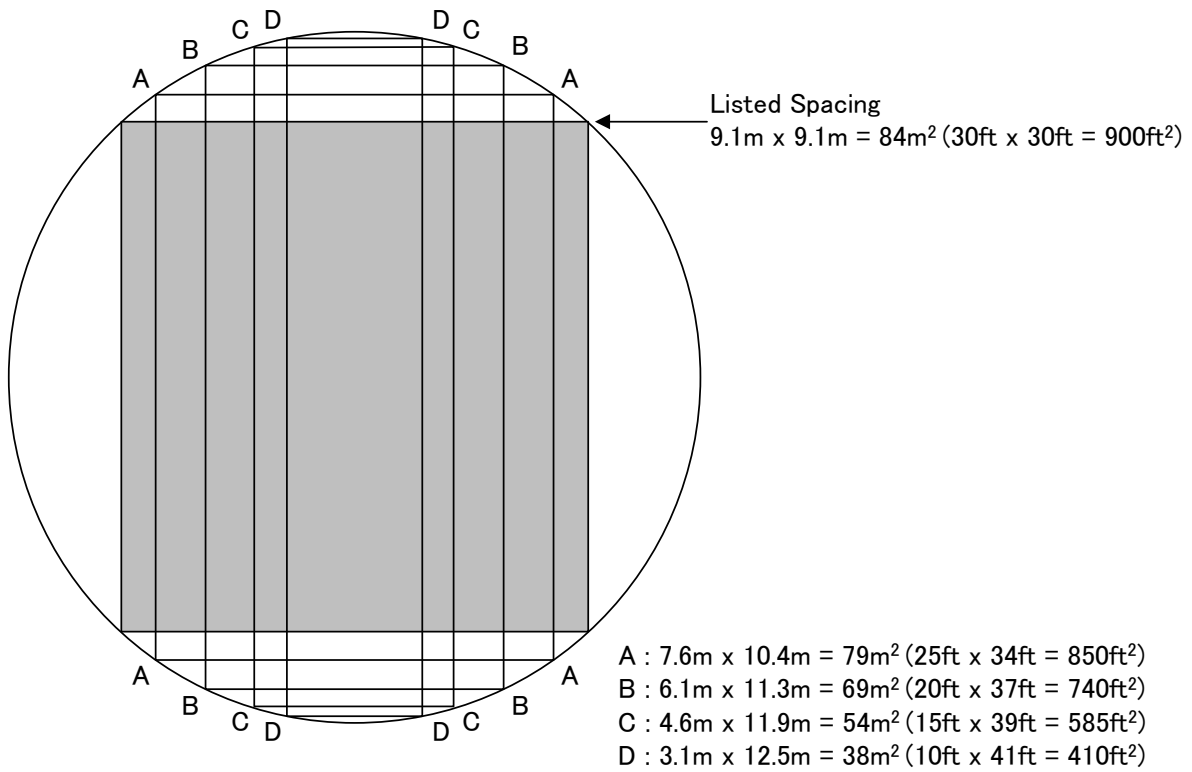

Figure 4: Alternative heat detector coverage configurations

When installed on the ceiling, spot type heat detectors must be located a minimum of 10 cm (4 in.) from side walls. When installed on side walls, the detector must be between 10 cm (4 in.) and 30 cm (12 in.) from the ceiling, as shown in Figure 5.

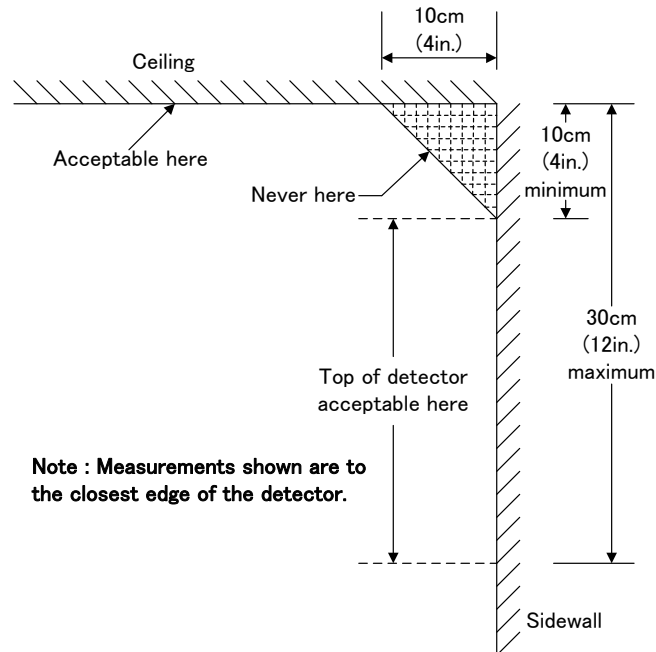

Figure 5: Detector placement near ceiling or wall joints

The following figure shows the required heat detector spacing for a 60.9 m (200 ft.) by 60.9 m (200 ft.) room with a 3m (10 ft.) ceiling. Figure 6 shows 16 heat detectors with the required spacing of $S = 15.2$ m (50 ft.).

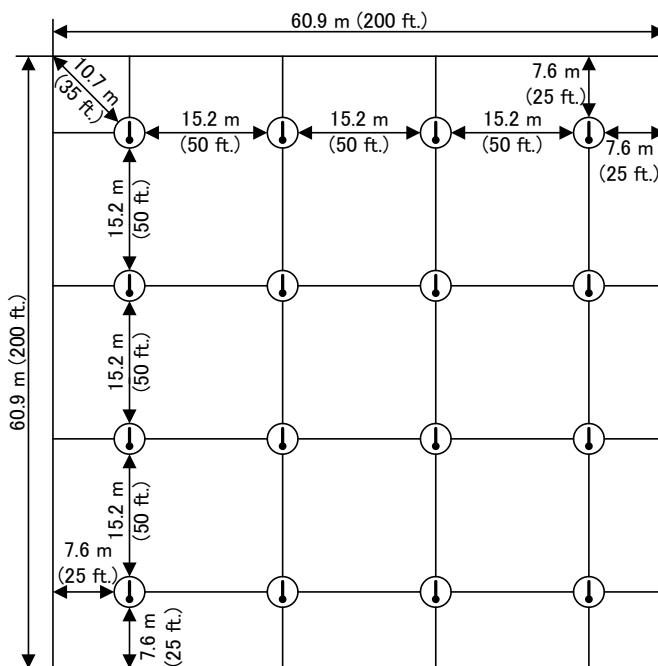

Figure 6: Heat detectors spacing example

7.2.2 Ceiling construction and heat detectors

When installing heat detectors on other than flat and smooth ceilings or at ceiling height greater than 3 m (10 ft.), spacing must be adjusted. The table below shows the reduction in listed spacing to be applied when detectors are mounted on ceilings higher than 3 m (10 ft.). This reduced spacing allows the detectors to have the equivalent response of detectors located on a 3 m (10 ft.) ceiling.

Ceiling height	Percent of listed spacing
0 to 3 m (0 to 10 ft.)	100
3 to 3.7 m (10 to 12 ft.)	91
3.7 to 4.3 m (12 to 14 ft.)	84
4.3 to 4.9 m (14 to 16 ft.)	77
4.9 to 5.5 m (16 to 18 ft.)	71
5.5 to 6.0 m (18 to 20 ft.)	64
6.0 to 6.7 m (20 to 22 ft.)	58
6.7 to 7.3 m (22 to 24 ft.)	52
7.3 to 7.9 m (24 to 26 ft.)	46
7.9 to 8.5 m (26 to 28 ft.)	40
8.5 to 9.1 m (28 to 30 ft.)	34

Spot type detector ceiling height reduction percentages

7.2.3 Exposed solid joists

Exposed solid ceiling joists may impede the heat flow to the detectors. A joist is defined as a solid member projecting down from the ceiling surface for a distance of more than 10 cm (4 in.) and spaced at intervals of 91 cm (36 in.) or less, center to center. The spacing of heat detectors must be reduced by 50% in the direction perpendicular to the joist. The detectors shall be mounted on the bottom of the joists.

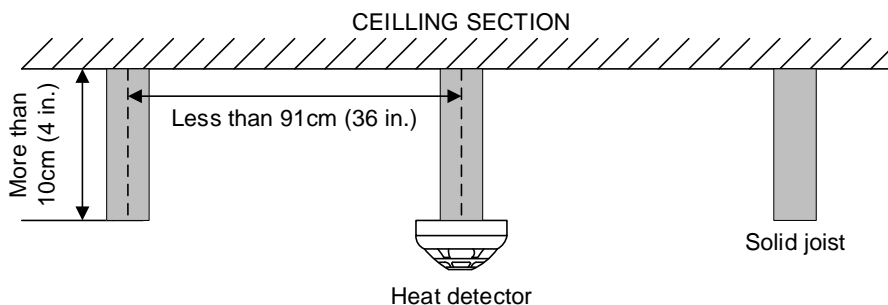

Figure 7: Heat detector spacing — solid joist construction (side view)

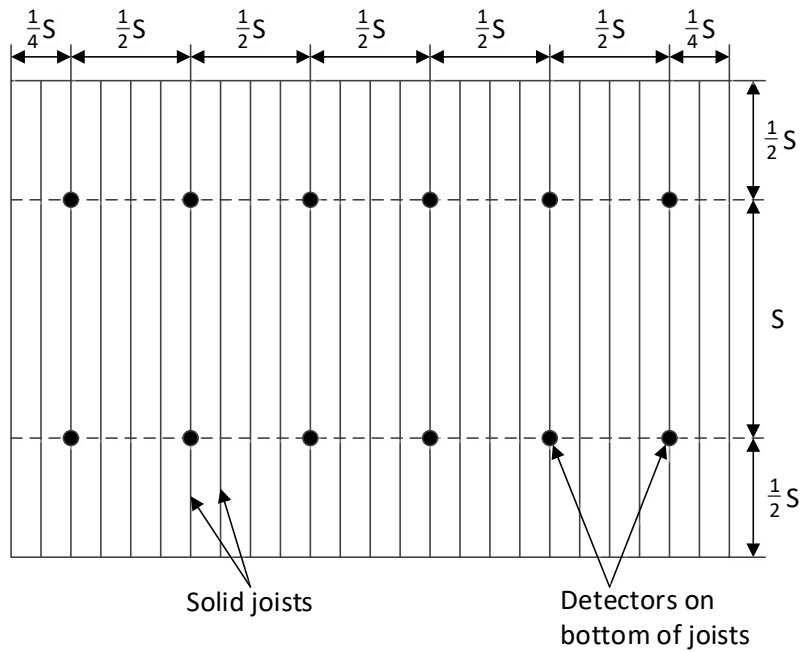

Figure 8: Heat detector spacing — solid joist construction (plan view)

7.2.4 Exposed beams

Exposed beams may impede the heat flow to the detectors. Beams are defined as members extending 10 cm (4 in.) or more down from the ceiling and spaced more than 91 cm (36 in.) apart. The spacing of heat detectors must be reduced by 33% in the direction perpendicular to the beam. Detectors can be mounted on the bottom of the beams which are less than 30.4 cm (12 in.) in depth and less than 2.4 m (8 ft.) on center. If beams are greater than 46 cm (18 in.) in depth and are spaced more than 2.4m (8 ft.) on center, then each bay formed by the beams must have at least one detector mounted on the ceiling. If the ratio of beam depth (D) to ceiling height (H), D/H, is greater than 0.1 and the ratio of beam spacing (W) to ceiling height (H), W/H, is greater than 0.4, heat detectors should be located between beams. If either the ratio of beam depth (D) to ceiling height (H), D/H, is less than 0.1 or the ratio of beam spacing (W) to ceiling height (H), W/H, is less than 0.4, heat detectors should be located on the bottom of the beams.

Calculation:

$D/H > 0.1$ AND $W/H > 0.4$: Mount the detector on the ceiling

$D/H < 0.1$ OR $W/H < 0.4$: Mount the detector on the bottom of the beam

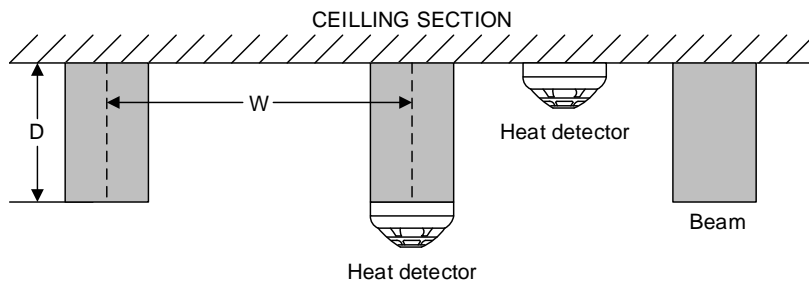
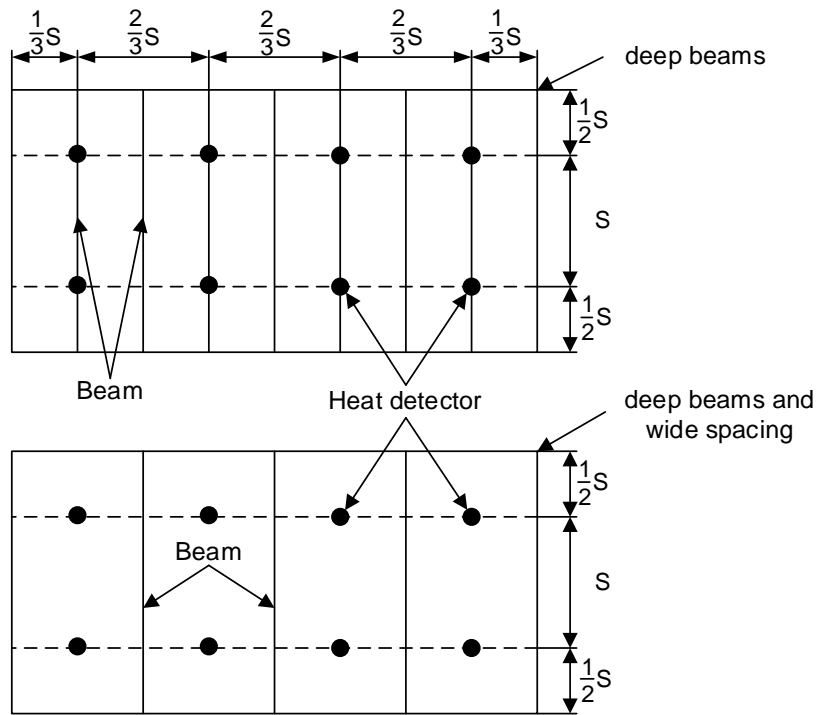

Figure 9: Heat detector spacing — beam construction (side view)



$S = 15 \text{ m (50 ft.)}$ $\frac{2}{3} S = 10 \text{ m (33 ft.)}$ $\frac{1}{2} S = 8 \text{ m (25 ft.)}$ $\frac{1}{3} S = 5 \text{ m (17 ft.)}$

Figure 10: Heat detector spacing — beam construction (plan view)

7.2.5 Sloping ceiling (peaked and shed)

In the rooms with peaked ceilings, the first row of detectors must be located within 91 cm (36 in.) (measured horizontally) of the ceiling peak, but not closer than 10 cm (4 in.) vertically to the peak. Additional detectors, if required, must be located based on the horizontal projection of the ceiling and the type of ceiling construction. In the rooms with shed ceilings having a slope greater than 1 m in 8 m (1 ft. in 8 ft.), the first row of detectors must be located within 91 cm (36 in.) of the high end of the ceiling. Additional detectors, if required, must be located based on the horizontal projection of the ceiling and the type of ceiling construction. For a ceiling slope of less than 30 degrees, all detectors must be spaced using the height at the peak. For a ceiling slope of 30 degrees or greater, all detectors must be spaced using the average slope height or the height of the peak.

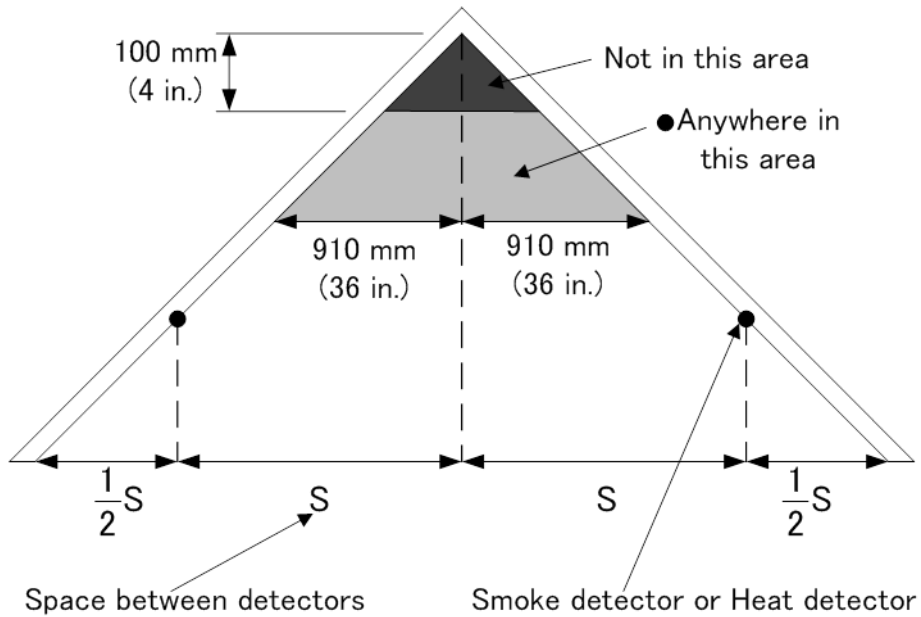

Figure 11: Heat detector spacing — Sloped ceiling (peaked type)

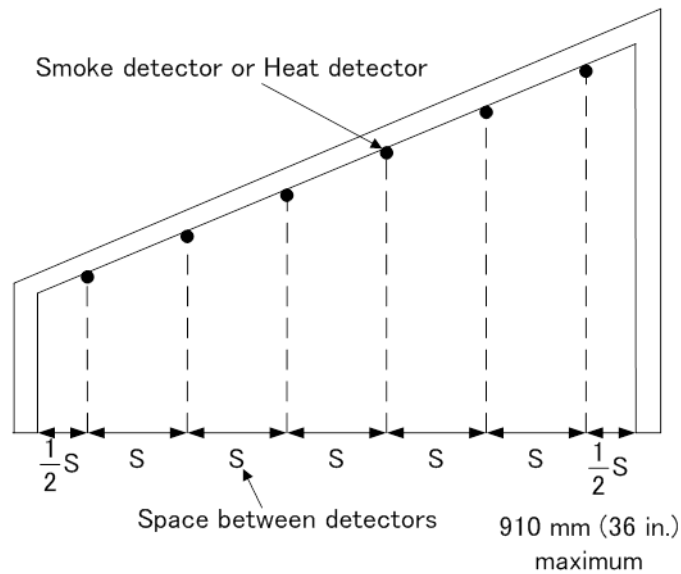

Figure 12: Heat detector spacing — Sloped ceiling (shed type)

7.3 Smoke detector applications

Smoke detectors are designed to sense the presence of smoke particles. In order to sense the particles, smoke detectors must be placed where smoke can reach them. When determining the location of smoke detectors, potential fire locations should first be evaluated, and paths of smoke flows should be determined. It is preferable to conduct actual field tests wherever it is practical to do so. It is desirable to locate smoke detectors at the points of intersection of smoke travel from potential fire sources throughout the area. Ceiling height, construction, and ventilation affect the performance of smoke detectors.

7.3.1 Avoidance of unwanted alarms

Smoke detectors can be affected by various environmental factors (other than smoke), which may accidentally activate the detectors. It is necessary to consider where smoke detectors should be installed in order to minimize unwanted alarms. Listed below are some common sources of unwanted alarms to be considered when locating smoke detectors.

- Steam and moisture
- Chemical fumes
- Cooking equipment
- Welding, cutting, and industrial processes
- Dust or lint
- Engine exhaust
- Vibration or shock
- Excessive airflow
- Lightning
- Radio frequency radiation

The smoke detector signals a dirty sensor trouble to the control panel when it reaches the preset limit. The dirty sensor trouble indicates the detector is in need of servicing.

7.3.2 Spacing of smoke detectors

The recommended spacing of spot type smoke detector is maximum 9.1 m (30 ft.), based on the detector installation on a smooth ceiling at 3 m (10 ft.) high. All points on the ceiling shall have a detector within a distance equal to or less than 0.7 times the nominal 9.1 m (30 ft.) spacing.

Note: It is recommended that smoke detectors be installed on $S = 9.1$ m (30 ft.) centers, on smooth ceilings. Refer to NFPA 72 National Fire Alarm Code for additional information on spacing adjustments.

Spot-type smoke detectors must be located on the ceiling or, if on a sidewall, between the ceiling and 30 cm (12 in.) down from the ceiling to the top of the detector.

7.3.3 Stratification

Stratification of air in a room can hinder smoke from reaching ceiling-mounted smoke detectors. In order to improve detection response in situations where stratification exists, it might be necessary to install additional smoke detectors on sidewalls or at locations below the ceiling, as shown in Figure 13.

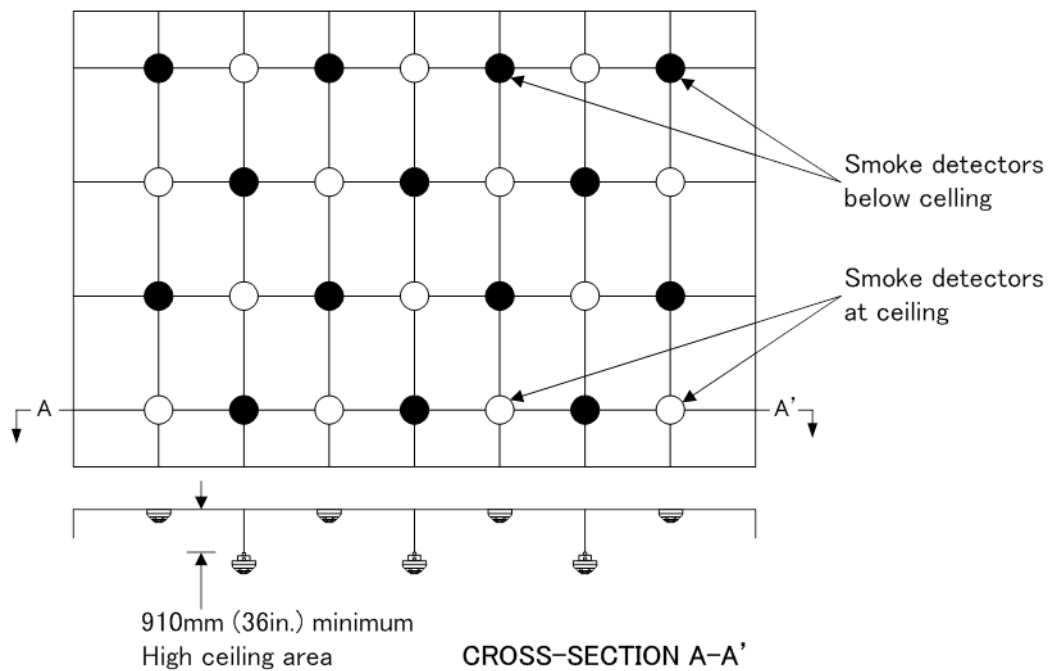

Figure 13: Smoke detector layout accounting for stratification

7.3.4 Partitions

It is recommended that the distance between smoke detectors should not exceed a nominal spacing of 9.1 m (30 ft.) and there should be detectors within a distance of one-half the nominal spacing, measured at right angles from all walls or partitions extending upward to within the top 15 percent of the ceiling height.

7.3.5 Exposed solid joists

Exposed solid joists may impede the flow of smoke to detectors. A joist is defined as greater than 10 cm (4 in.) in depth and spaced less than 91 cm (3 ft.) apart. The detectors must be mounted on the bottom of the joists.

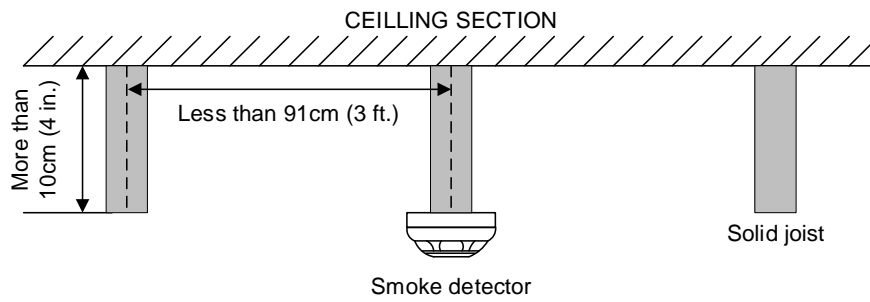

Figure 14: Smoke detector spacing — solid joist construction (side view)

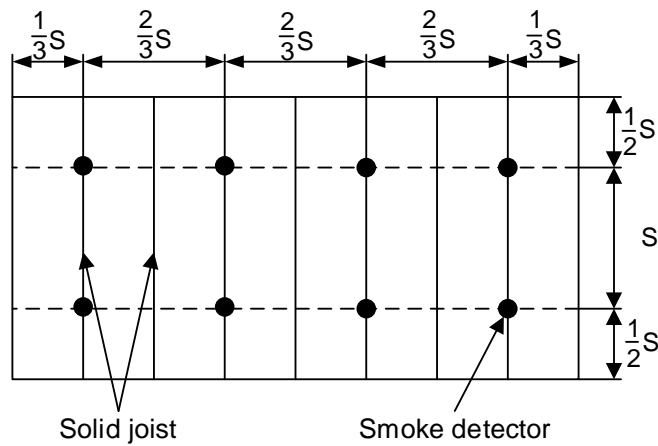

Figure 15: Smoke detector spacing — solid joist construction (plan view)

7.3.6 Exposed beams

Beams are defined as any members extending 10 cm (4 in.) or more down from the ceiling and spaced more than 91 cm (3 ft.) apart. The spacing of smoke detectors must be reduced in the direction perpendicular to the beam.

Smoke detectors shall be located on the ceiling in each beam pocket if the ratio of beam depth (D) to ceiling height (H), D/H, is greater than 0.1, and the ratio of beam spacing (W) to ceiling height (H), W/H, is greater than 0.4. Smoke detectors shall be located on the bottom of each beam if either the ratio of beam depth (D) to ceiling height (H), D/H, is less than 0.1, or the ratio of beam spacing (W) to ceiling height (H), W/H, is less than 0.4.

Calculation:

$D/H > 0.1$ and $W/H > 0.4$: Mount the detector on the ceiling

$D/H < 0.1$ or $W/H < 0.4$: Mount the detector on the bottom of the beam

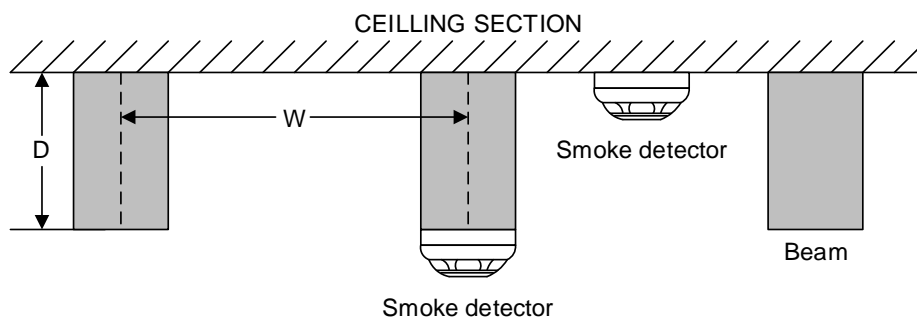

Figure 16: Smoke detector spacing — beam construction (side view)

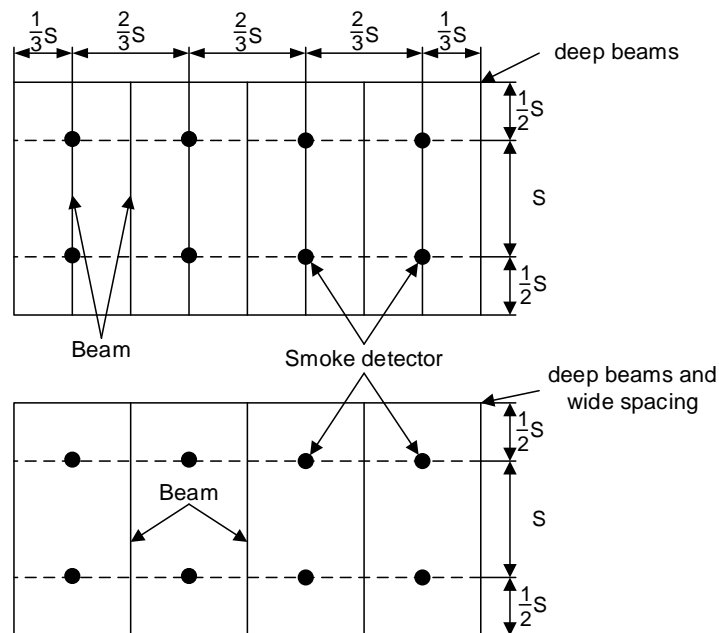

Figure 17: Smoke detector spacing — beam construction (plan view)

7.3.7 Sloping ceiling

Refer to 7.2.5.

7.4 Procedure for installing

Note: All wiring must be installed in compliance with the National Electrical Code, applicable local codes and the Authority Having Jurisdiction.

Proper wire gauges should be used. The installation wires should be color coded to limit wiring mistakes and ease system troubleshooting. Improper connections will prevent a system from responding properly in the event of a fire.

Remove power from the communication line before installing detectors.

1. Pass the field wiring through the rear center cable opening in the mounting base. Install the base to the electrical box with screws via the base mounting holes. Connect the field wiring to the base terminals, as detailed in Figure 18. Do not use looped wire under terminals (See Figure 19).
2. Using the EVA-AD2 Address Programmer, set the desired address for each detector. See Annex A for the handling.
3. Install the detector into the mounting base, making sure the wiring does not obstruct mounting of the detector head. Push the detector into the mounting base while turning it clockwise until the detector locks into place. Use a small hexagonal wrench to set the tamper resist feature (if required), see Figure 20.
4. After the detector has been installed, snap on the supplied plastic dust cover onto the detector to keep out dust during construction.
5. Apply power to the control panel to configure the detectors to the fire alarm control panel.
6. Test the detector(s) as described in the TESTING section of this manual.

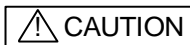

Use appropriate access equipment as required for safe work at height. Otherwise there is a risk of falling.

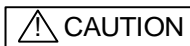

The dust cover needs to be removed after commissioning is completed.

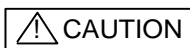

Smoke and heat detectors are not to be used with detector guards unless the combination has been evaluated and found suitable for that purpose.

- Notes:**
- If the dust cover is not used while construction work is being completed, exposure to a slightly dusty environment can cause unwanted alarms after the commissioning the detectors.
 - In the event of an unwanted alarm after commissioning clean the detector and re-install.
 - If the detector still produces unwanted alarms replace the detector.

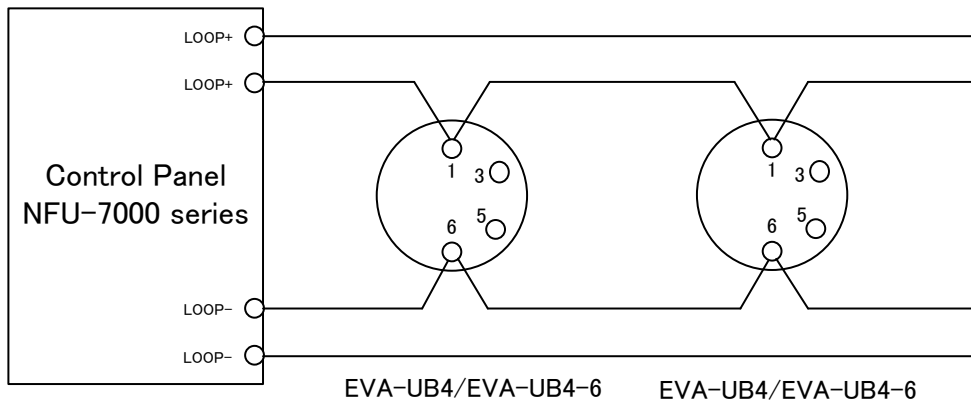

Figure 18: Wiring diagram for EVA-UB4 and EVA-UB4-6

SLC Line impedance is 50Ω at maximum and the maximum length is 2km.

Refer to the manual of control panel NFU-7000 series to determine correct maximum loop load and maximum loop resistance for devices connected to each loop.

CAUTION

Use cable AWG12-20 for wiring. Do not connect different gauge cables at one terminal in order to prevent loosening.

CAUTION

Do not connect cables in reverse polarity. Failure to connect the polarity correctly could result in damage to other equipment.

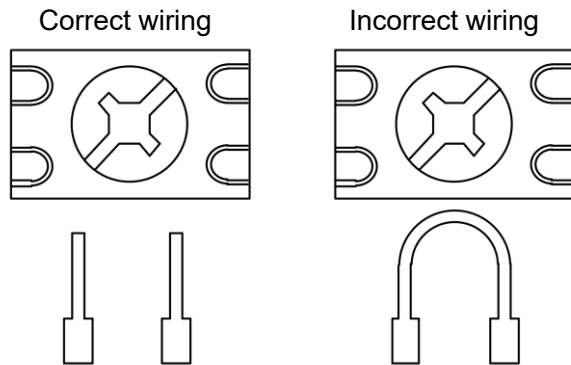

Figure 19: Correct and incorrect wiring method

CAUTION

For system monitoring — For terminals 1 and 6 do not use looped wire under terminals. Break wire run to provide monitoring of connections.

7.5 Tamper resistance feature

The EVA-UB series, EVA-S6 Base, and EVA-STB series of smoke/heat detector mounting bases have a tamper-resist feature that works in conjunction with the detectors. When this feature is enabled, the detectors cannot be removed from the base without the use of a small hexagonal wrench. To avoid unauthorized removal of the detector, turn the locking screw in the mounting base counterclockwise until the screw extends out about 4 mm (3/16 in.) from the rim of the base, as shown in Figure 20.

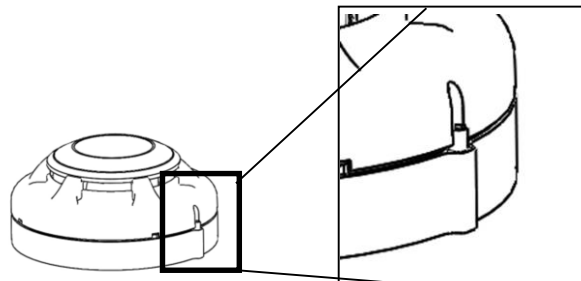

Figure 20: Position of the locking screw to lock the detector

Note: If the detector is installed on a high ceiling where a tool (ladder, etc.) is needed, it is not recommended to use the locking screw.

Section 8 – TESTING

Notes:

- Before testing, notify the proper authorities that the system is undergoing maintenance, and will temporarily be out of service.
- Disable the system to prevent unwanted alarms.
- All sensors must be tested after installation and periodically thereafter.
- Testing methods must satisfy the Authority Having Jurisdiction (AHJ).
- When carrying out site testing of the detector, the control panel must be set to “One Man Walk Test” mode prior to the test.

Sensors offer maximum performance when tested and maintained in compliance with NFPA 72. The sensor may be tested in the following ways:

- A. Direct Heat Method (Hair dryer of 1000 – 1500 watts)
1. From the side of the detector, direct the heat toward the sensor. Hold the heat source about 15 cm (6 in.) away to prevent damage to the cover during testing.
 2. The red LED on the detector should light when the temperature at the heat detector reaches the alarm set point. If the red LED indicator fails to light, check the power to the detector and the wiring in the detector base.
 3. After the detector has given the alarm condition, the detector automatically is reset by the control panel. The detector can also be reset at the control panel manually. Detectors that fail these tests should be cleaned as described under MAINTENANCE Section and retested. If the detectors still fail these tests they should be returned for repair.

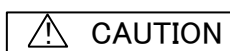

Do not use heat guns used for paint stripping or soldering pipes, as these heat guns generate sufficient heat to damage the detector. The heat guns should not be used for testing heat detectors.

B. For the smoke detector testing (Go / No-Go)

1. To test the optical detector, introduce a certain amount of aerosol into the detector's head, using HSI FIRE & SAFETY Aerosol canned smoke tester "30S". Please follow the manufacturer's recommendations on its use.
2. Check that the detector gives an alarm condition within 15 seconds. Check the red LED indicator is on and the green LED is flashing on the **EVA-PYH3** combination detector. If the red LED fails to light, check the power to the detector and the wiring in the detector base.
3. After the detector has given the alarm condition, the detector automatically is reset by the control panel. It may be necessary to allow a short time to elapse before resetting the detectors, to allow any residual aerosol from the test to disperse.
4. Detectors that fail these tests should be cleaned as described under MAINTENANCE Section and retested. If the detectors still fail these tests they should be returned for repair.
5. Before proceeding to the next detector, ensure that the detector previously tested does not re-operate due to the presence of residual aerosol.

Section 9 - MAINTENANCE

- Notes:**
- Before cleaning, notify the proper authorities that the system is undergoing maintenance, and therefore the system will temporarily be out of service.
 - Disable the loop or system undergoing maintenance to prevent unwanted alarms.

It is recommended that the sensor be removed from its mounting base for easier cleaning and that sensors be cleaned at least once a year.

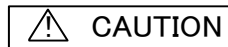

Do not disassemble, repair, or modify the products. It may cause a fire or electric shock.

1. Carefully remove the detector head from its base.
2. Use a soft, lint-free cloth, moistened with alcohol for sticky deposits, to clean the plastic enclosure.
3. Using a soft bristle brush (e.g. an artist's paint-brush) carefully brush around the thermistor, avoiding touching the thermistor and photo chamber.
4. Ensure that no debris remains on or around the thermistor or photo chamber once cleaning is complete.
5. Reinstall the detector.
6. Test the detector according to Section 8 - TESTING.
7. Set the system back to normal operation mode.
8. Notify the proper authorities that the system is back on line.

Section 10 – SPECIFICATIONS

Table 3: Specifications

Detector Element	Smoke : Light Emitting Diode Photo Diode
	Heat: Thermistor
LED Visual Indicator	Stand-by: Flashing green LED
	Alarm: Solid red LED with flashing green
Operating Voltage Range	20 VDC to 38 VDC peak
System Voltage	35VDC
Stand-by Current	200 μ A
Alarm Current (with red LED)	6 mA
Sensitivity	1.09 %/Ft. to 1.89 %/Ft.
Fixed Heat Alarm Temperature	57 °C (135 °F)
Rate of Rise Detection	8.3°C (15 °F)/min.
UL Ambient Installation Temperature	0 °C to +38 °C (32 °F to 100 °F)
Operating Temperature	-10 °C to +55 °C (14 °F to 131 °F)
Storage Temperature	-40 °C to +70 °C (-40 °F to 158 °F)
Relative Humidity	\leq RH95% non-condensing
Addressing Method	Soft addressing, Non-Volatile EEPROM
Address	1-254 (decimal)
Maximum Quantity per Loop	254 units (See Note 1)
Dimensions	Φ 104mm D x 42mm H (Φ 4.1" x 1.65" H) (Detector head)
	Φ 104mm x 15mm H (Φ 4.1" x 0.59" H) (with EVA-UB4 base)
Weight	115g (Detector head only)
	175g (Detector head and EVA-UB4)
Standard	UL268 7th edition and UL521

Note 1: Please refer to the Control Panel detailed procedures for complete instruction on additional technical details pertaining to this connection.

FOR WARRANTY SERVICE, RETURN TO:

OVERSEAS BUSINESS DIVISION

NITTAN COMPANY, LIMITED

1-54-5 SASAZUKA, SHIBUYA-KU, TOKYO, 151-8535, JAPAN

<https://www.nittan.com/english>

Section 11 – WARRANTIES

1. Nittan warrants to the customers that:
 - (a) all products supplied hereunder will be of merchantable quality and will comply with any specification agreed between Nittan and customer.
 - (b) it is not aware of any rights of any third party in the market which would or might render the sale of the products, or the use of any of the trade marks on or in products, or the use of any of the trade marks on or in relation to the products, unlawful.
2. In the event of any breach of the Nittan's warranty in Clause 1.(a) whether by reason of defective materials, production faults or otherwise, Nittan's liability shall be limited to:
 - (a) replacement of the products in question; or
 - (b) at the Nittan's option, repayment of the price where this had been paid.
And the warranty period is three (3) years from the shipment from Nittan's factory.
3. Notwithstanding anything to the contrary in this warranty terms, Nittan shall not be liable to the customer by reason of any representation or implied warranty, condition or other term or any duty at common law, or under the express terms of this warranty terms, for any consequential loss or damage whether for loss of profit or otherwise and whether occasioned by the negligence of Nittan or its employees or agents or otherwise, arising out of or in connection with any act or omission of Nittan relating to Nittan or supply of the products, their use by any customer.
4. Customer shall indemnify Nittan against all loss, damages, liabilities, costs and expenses which Nittan may suffer or incur as a result of or in connection with any breach by customer of this warranties terms or any laws or regulations of any jurisdiction or any rules of any governing authorities.

Pressing any key at any time during the information collection cycle, forces the EVA-AD2 to display the address, and await new address selection.

Set new address

1. +100, +10, +1 keys are used to select the new address.
2. Press the [Set] key
 - a) The buzzer sounds, and all LED's are turned off. The EVA-AD2 then starts transmitting to the detector.
 - b) Do not remove the detector.
3. The 7 segment LED shows the new address and "complete" LED lights. If an unsupported or defective device is connected the buzzer sounds, ERROR LED is lit and the 7 segment LED reads ERROR CODE.
4. To continue changing the address for another device, change the detector and then repeat from paragraph 3.

To finish changing addresses, turn the POWER SW off.